

REVISIONS				DWN	DATE
ITEM REV	DWG REV	ECO	DESCRIPTION		
A	1	-	INITIAL RELEASE.	CPO	12-18-15

NOTES:

- CONNECTOR FOR J2: MOST WELL MWFPC05PSN-H20-24
- CONNECTOR FOR J4: MOST WELL MWFPC05PSN-H20-34
- CONNECTOR FOR J3: MOST WELL W2000-R2051221
- MATING CONNECTOR FOR J3: MOST WELL A2001H-05P

5.00±.50
MAX COMPONENT HEIGHT

1.02±0.10

19.05

9.52

DETAIL A

J3	
PIN	FUNCTION
1	GROUND
2	USB_5V
3	GROUND
4	D+
5	D-

CT10388-A-1
FW00402-A-1
MMDDYYhhmmss S/N

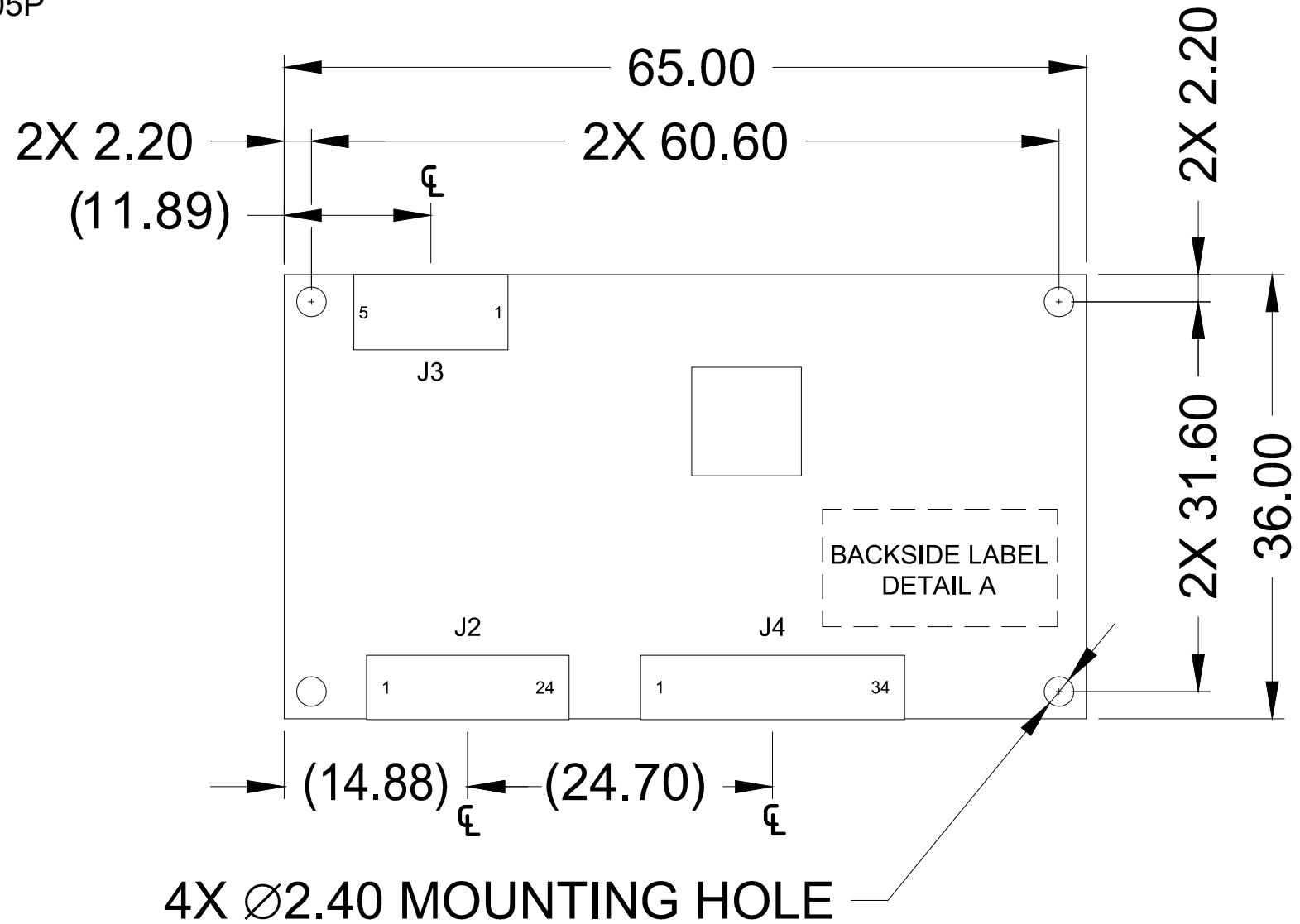

4X Ø2.40 MOUNTING HOLE



1016 North Lincoln Avenue, Pittsburgh, PA 15233
1.800.366.1904 - 412.322.9900 - Fax: 412.322.9958
e-mail: sales@dawar.com - www.dawar.com

THIS CONFIDENTIAL DOCUMENT IS THE PROPERTY OF DAWAR TECHNOLOGIES, INC. AND SHALL NOT BE COPIED, REPRODUCED, DISCLOSED, AND/OR USED AS THE BASIS FOR MANUFACTURING OR SALE WITHOUT PERMISSION OF A DULY AUTHORIZED REPRESENTATIVE OF DAWAR TECHNOLOGIES, INC.

FIRMWARE FW00402-A-1	DESCRIPTION ATMEL PCB - 1664T3 USB 24x34 PCAP CONTROLLER (DW01836)
-------------------------	---

ITEM/DRAWING NO. CT10388-A	DWG REV 1
UNIT mm [INCH]	TOLERANCE ±0.25 [0.010] UNLESS SPECIFIED
SHEET 1 OF 1	DRAWN BY OSTROWSKI
DATE 12-18-15	